

LINDU

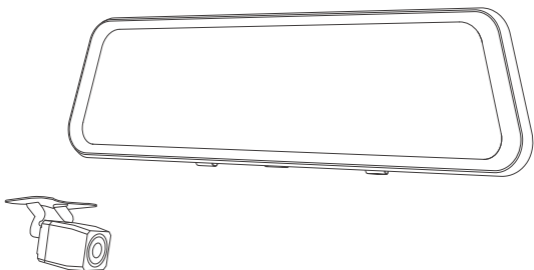

Mirror Dash Cam

LD4K 4K+2.5K (V1.0)

Table of Contents

Warranty & Introduction.....	02
1. Settings Started.....	03
What's Included.....	03
Installation.....	04
Specification.....	08
Diagram.....	09
2. Product Overview.....	10
3. Using the Dash Cam.....	12
First Time Use.....	12
How to Format microSD Card	13
How to Connect LINGDU APP	13
How to Download Video into Mobile Phone.....	16
How to View Video on Dash Cam.....	18
How to View Video on Computer.....	19
How to Update Firmware.....	21
4. Smart Driving Features.....	22
ADAS (Advanced Driver Assistance Systems).....	22
BSD (Blind Spot Detection).....	23
LCA (Lane Change Assistance).....	24
5. Setting the Dash Cam.....	24
6. Setting the System.....	27
7. Compliance and Security.....	29
General Troubleshooting.....	29
Important Safety Information.....	31
Notice.....	33

Warranty & Introduction

Thank you for purchasing this LNDU dashcam. This instruction manual contains information on how to operate your dashcam. Before using your dashcam, we recommend that you read through this manual to ensure correct usage. To improve the performance of the product, the contents of this manual are subject to change without prior notice. Please read and understand the manual before operating.

- ① Please ALWAYS connect with power when using.
- ② LD4K comes with an LNDU 64GB memory card in the package. Please format your memory card before first use to ensure better recording.



service@lingdu.us

Scan QR code to download Manual

1 / SETTINGS STARTED

What's Included

The package contains the following accessories. If any accessories are missing after receiving the goods, please contact us as soon as possible.

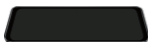

Mirror Dash Cam



Rear Camera



Type-C USB
Car Charger



GPS Module



Anti-Glare Film



Cable Clip*5



Pry Tool



Cleaning Wipes



Cleaning Cloth



64GB microSD Card



User Manual



Straps

PLEASE NOTE: LD4K comes with a 64GB microSD card. The LD4K dash cam supports memory cards of up to 512GB. We recommend using a Class 10, U3, A2 Speed microSD memory card. Unqualified memory cards may cause the dash cam to restart repeatedly or incomplete recordings. Please format your memory card before first use to ensure better recording.

Installation



Please scan the QR code to watch the installation video.

Mount the Mirror Dash Cam

※ There are two sets of straps (different lengths) supplied with the Stream Media Mirror Dash Camera, select the size to best suit your vehicle's rear-view mirror.

※ The straps should be a tight fit when fitted, thus ensuring the Stream Media Mirror Dash Camera is securely fitted to the existing rear-view mirror.

① Attach the upper end of the straps to the retaining hooks on the top of the rear-view mirror.

② Put the mirror dash cam in position on the front face of your existing rear view mirror.

Extend the straps around the back of the rear-view mirror and attach them to the bottom retaining hooks.

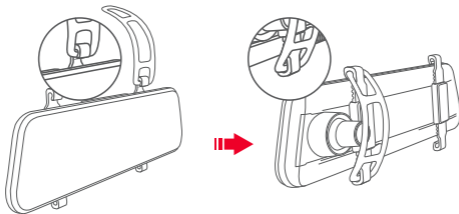

Apply the Anti-glare Film

1. Peel the protective paper cover off the film and apply it to the monitor.
2. Start in the top left corner and smooth the plastic against the monitor carefully to avoid trapping air between the monitor and the film.

PLEASE NOTE: Anti-glare film only reduce the glare but not eliminate the glare.

Rear Camera Installation

The rear camera equipped with a 6-meter cable is to connect to the dash-cam via AV port. Before installation, please check if the provided cable is long enough to reach the rear cam in your car.

Position A: Install the rear camera on the rear windshield. Position A is designed for live stream rear review only, not for reversing guide. The installation is easier.

Position B: Install the rear camera near the license plate. The back image is crisp and clear for both rear viewing and reversing guide.

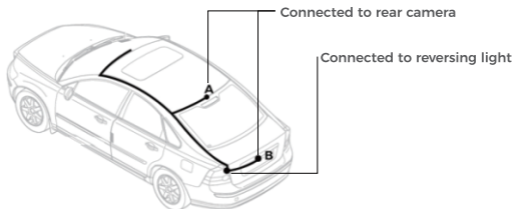

Instructions for Reverse Trigger Wiring

To use the reversing function, install the rear camera in position B, then connect the red cable of rear camera extension cable to the anode of the car reversing lamp.

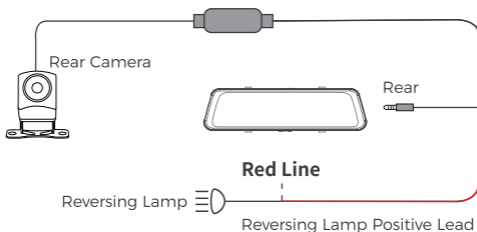

Wire Layout in the Vehicle

1. Plug the car charger into the mirror dash cam and connect it to the cigarette lighter.
2. Attach the GPS module to the GPS port, remove its sticker, and place it on your car dashboard.
3. Start your car's ignition and watch as the dashcam powers on automatically.

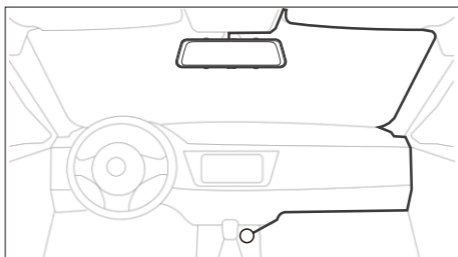

Specification

Model	LD4K
Screen Size	12 Inch Touch Screen
Aperture	F=1.8
Color	Black
Language	English, 简体中文, 繁體中文, Deutsch, Italiano, Español, Русский, Français
Video Format	MP4
Photo Foemat	JPG
Video Code	H.264/ H.265
Video Resolution	Front and Rear: 4K (3840*2160P) 25FPS + 2.5K (2560*1440P) 25FPS (Default) 4K (3840*2160P) 25FPS + 1080P 25FPS 2.5K (2560*1440P) 25FPS + 2.5K (2560*1440P) 25FPS 2.5K (2560*1440P) 25FPS + 1080P 25FPS 1080P 25FPS + 1080P 25FPS
G-sensor	Built-in 3-Axis Acceleration Sensor
Loop Recording	Support
Parking Mode	Support (ONLY works when the dash cam is connected to 3-Lead Hardwire Kit)
Memory	Max support 512GB (Class 10, U3 Speed)
Microphone	Built-in
Speaker	Built-in
Power Interface	5V/ 2.5A
Working Temperature	-20°C to 65°C (-4°F to 149°F)

Diagram

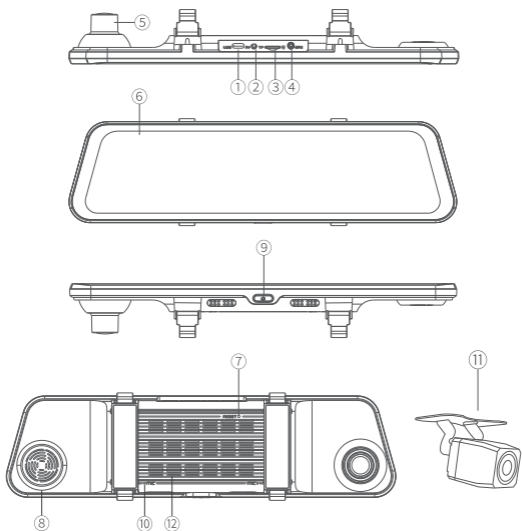

- | | | |
|----------------------------|----------------|---------------|
| ① Type C USB Charging Port | ⑤ Front Camera | ⑨ Power |
| ② Rear Camera Slot (AV-IN) | ⑥ Touch Screen | ⑩ MIC |
| ③ TF Card Slot | ⑦ Reset | ⑪ Rear Camera |
| ④ GPS Port | ⑧ Speaker | ⑫ Vent |

2/ PRODUCT OVERVIEW

UI

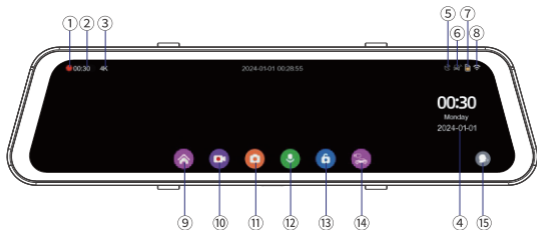

①Recording Indicator

②Loop Recording Timer

③Video Resolution

④Date/Time

⑤GPS Indicator

⑥Parking Monitor

⑦microSD Card Indicator

⑧WiFi Indicator

⑨Home

⑩Start/Stop Recording

⑪Take Photo

⑫Mic

⑬Lock/Unlock File

⑭Switch Display

⑮Voice Control

Operation

Adjust the Angle: Slide up and down on the left side.



Adjust the Brightness: Slide up and down on the right side.



Switch the Camera Display: Slide left and right.

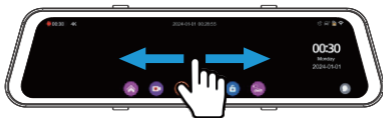

3/ USING THE DASH CAM

First Time Use

For a better user experience, please refer to the following steps for the first use:

1. For the longevity of the dash cam, please use the car charger included in our package and ensure that the output power can reach 5V/ 2.5A. Unstable power supply or insufficient input current will cause the dash cam to automatically switch on or off or not turn on.

2. Please insert the memory card in the correct direction.

PLEASE NOTE: LD4K comes with an LNDU 64GB memory card in the package. We recommend using a Class 10, U3, A2 Speed microSD memory card. LD4K dash cam supports memory cards of up to 512GB. Unqualified memory cards may cause the dash cam to restart repeatedly or incomplete recordings. Please format your memory card before first use to ensure better recording.

3. After confirming that the power supply and rear camera are correctly connected and the memory card has been inserted into the dash cam, you can turn on the dash cam and use it. (Removing accessories during the startup process will cause the dash cam to shut down).

4. Setting "  "> System Settings > Time Zone Selection > Select local time zone.

After completing the above settings, you can pre-set the dash cam according to your driving habits. LNDU wishes you a smooth

journey. If you encounter any problems during use, please contact us through the following methods:

Email: service@lingdu.us

How to Format microSD Card

A. Formatting the Memory Card by the Dash cam

Setting "  "> System Settings > Disk Formatting > Confirm.

B. Formatting the Memory Card by the LINGDU APP

1. Install the LINGDU App.
2. Connect to the dash cam via Wi-Fi.
3. Access the real-time preview page.
4. Pause the recording, then tap the settings button in the upper right corner of the live preview page.
5. In the settings menu, find the option to format the microSD card. Select it and confirm the operation.
6. You will see a pop-up message indicating that formatting is in progress.

How to Connect LINGDU APP

1. Search for the LINGDU App in the Google Play Store or Apple App Store and install it on your smartphone.



2. Turn on the WiFi of the dash cam: "🏠" > System Settings > Wi-Fi Info > Wi-Fi Switch.

PLEASE NOTE: Some mobile phones do not support 5G WiFi. If you cannot find the WiFi of our dash cam in the WiFi list, please try to switch to 2.4G WiFi.

3. Please connect to our dash cam's WiFi on your mobile phone before opening the LINGDU App.

WiFi Name SSID: LNDU LD4K_*****

Default Password: 12345678

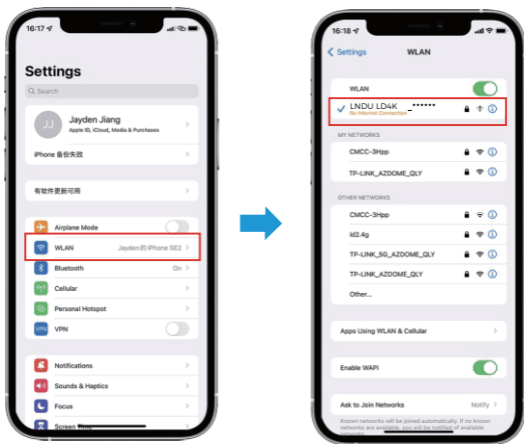

4. Ensure your phone is connected to the dashcam's WiFi. Once connected, the App interface will display the dashcam model LD4K. Tap "Check Real-time Video" to access the "Live Video Preview" interface, where you can view the currently recorded video in real time.

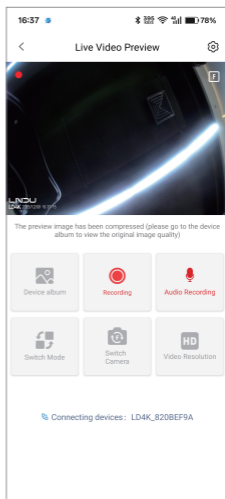
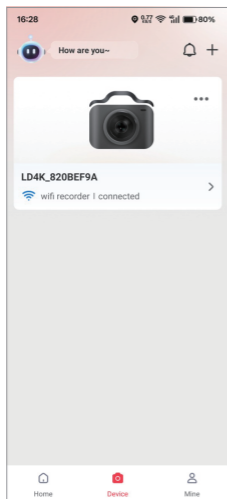

How to Download Video into Mobile Phone

1. Go to "Live Video Preview" interface. Please STOP recording first, then press the "Dashcam Albums" to get Photo, Video, Emergency files.

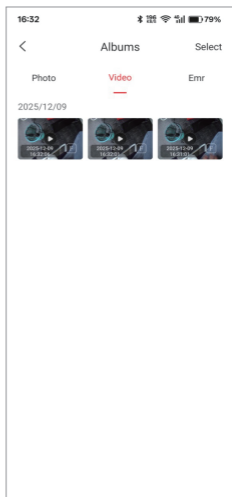
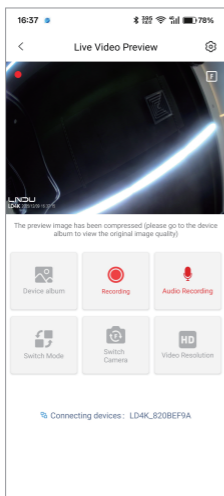

2. Select the video files you wish to download to your phone. Once downloaded, these files can be found in the app's original interface under the "Local Video" menu. Please note that downloading a video file may take some time.

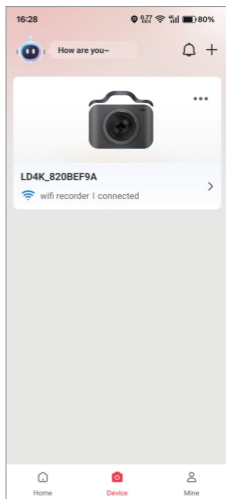

How to View Video on Dash Cam

1. Please click "🏠" > "File Explorer" to enter playback mode.



2. Select the file you want to view:

Video: Normally recorded video. When loop recording mode is turned on, the latest video will replace the oldest video when the memory card is full.

Video-Lock: Video locked when the G-sensor senses a collision/
Video locked manually by the user through voice control or touch. When loop recording mode is turned on, the locked video will not be replaced by the latest video when the memory card is full.

Image: Photos taken by users through voice control or touch.

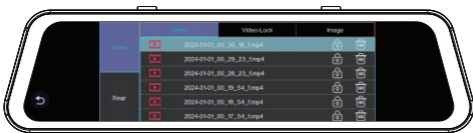

3. Click to view the video you want to view.



"🏠" Return to previous level.

Method 2:

Select from "PC" and find the memory card disk, you should be able to see drive "D" or "E" or other name depending on the pre-installed hard drives. Once you find the added flashdrive, double click in it, then you will see the file LNDU folder.

Video: Normally recorded video. When loop recording mode is turned on, the latest video will replace the oldest video when the memory card is full.

Video-Lock: Video locked when the G-sensor senses a collision/
Video locked manually by the user through voice control or touch. When loop recording mode is turned on, the locked video will not be replaced by the latest video when the memory card is full.

Image: Photos taken by users through voice control or touch.

电脑 > LNDU(F:) v 🔄			
名称	修改日期	类型	大小
back_emr	2024/12/23 5:59	文件夹	
back_norm	2024/12/23 6:12	文件夹	
back_photo	2024/12/12 3:00	文件夹	
front_emr	2024/12/23 5:59	文件夹	
front_norm	2024/12/23 6:12	文件夹	
front_photo	2024/12/12 3:00	文件夹	
GPS_Player	2024/12/12 2:16	文本文档	11

Choose one video file you want to play, you can drag and drop the file directly to the player. You can get the GPS information on the player.

How to Update Firmware

When the camera doesn't respond to your operation and the resetting doesn't help, it's useful to update to the latest firmware. Please follow these steps to update the firmware:

1. Format microSD Card

You can do this by going into the camera's system settings.

PLEASE NOTE: Make sure to backup your recordings if you need them before formatting the microSD Card.

2. Insert the card into the microSD Card reader and connect it to a computer.

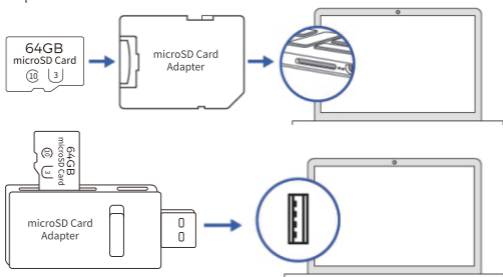

3. According to the original firmware version in your dash cam, choose the correct firmware to download it from LNDU official website to download the Latest Firmware

<https://www.lingdu.us> > Support > Download > LNDU Firmware > LNDU LD4K Firmware.

4. Unzip the firmware package and copy all files containing "update" in their names to the root directory of the memory card.

5. After powering on the device and inserting the memory card with the upgrade software, the dashcam will initiate the firmware update process. A progress bar will be displayed on the screen during the update. Once the update is complete, the dashcam will automatically restart.

4/ SMART DRIVING FEATURES

Please click "🏠" to enter main interface, then click "Smart Driving". There are 3 smart driving features: ADAS, BSD and LCA.

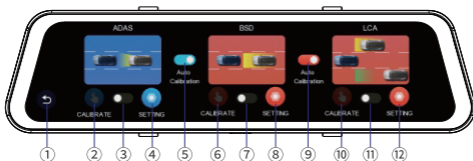

- ① Return to Main Interface
- ② ADAS Manual Calibration
- ③ ADAS Warning On/Off
- ④ ADAS Warning Settings
- ⑤ ADAS Auto Calibration
- ⑥ BSD Manual Calibration
- ⑦ BSD Warning On/Off
- ⑧ BSD Warning Settings
- ⑨ BSD & LCA Auto Calibration
- ⑩ LCA Manual Calibration
- ⑪ LCA Warning On/Off
- ⑫ LCA Warning Settings

ADAS (Advanced Driver Assistance Systems)

1. The ADAS function encompasses "Forward Collision Warning", "Lane Departure Warning", "Pedestrian Collision Warning", "Front Vehicle Start Warning" and "Close Distance Warning" features. It aims to enhance safety, improve driving performance, and reduce the likelihood of accidents.

2. Calibration: Tap the ADAS calibration icon to enter the calibration interface (as shown in the picture).



3. Settings Configuration:

Alarm Sensitivity - OFF, Low, Medium, High

Alarm Tone - OFF, ON

Lane Lines and Box Display - OFF, ON

BSD (Blind Spot Detection)

1. The BSD function enhances safety by monitoring the area alongside and behind your vehicle. It provides warnings for vehicles or objects in your blind spots to reduce the risk of accidents during lane changes or merges.

2. Calibration: Tap the BSD calibration icon to enter the calibration interface (as shown in the picture).



The framed area within the image represents the blind spot alert zone. Tap "▲" to move the red dot in the frame up, tap "▶" to move it right, tap "▼" to move it down, tap "◀" to move it left, and tap "■" to switch the red dot in the frame. Once the settings are complete, tap "SAVE" to save.

3. Settings Configuration:

Alarm Sensitivity - Low, Medium, High

Speed Threshold - 0 km/h, 10 km/h, 20 km/h, 30 km/h, 50 km/h

Alarm Tone - OFF, ON

Alarm Area Display - OFF, ON

LCA (Lane Change Assistance)

1. The LCA function works in tandem with BSD to support safe lane changes. It alerts the driver if it detects vehicles in adjacent lanes that may pose a risk during the lane change maneuver.
2. Calibration: Tap the LCA calibration icon to enter the calibration interface (as shown in the picture).



3. Settings Configuration:

Alarm Sensitivity - Low, Medium, High

Speed Threshold - 0 km/h, 30 km/h, 50 km/h, 80 km/h, 100 km/h

Alarm Tone - OFF, ON

Alarm Area Display - OFF, ON

Note: If the recording resolution is set to 4K and then you turn on BSD and LCA, the resolution will automatically switch to 2.5K. Conversely, if you enable BSD and LCA first and then set the resolution to 4K, BSD and LCA will automatically turn off.

5/ SETTING THE DASH CAM

Record Resolution

Front and Rear:

4K (3840*2160P) 25FPS + 2.5K (2560*1440P) 25FPS (Default)

4K (3840*2160P) 25FPS + 1080P 25FPS

2.5K (2560*1440P) 25FPS + 2.5K (2560*1440P) 25FPS

2.5K (2560*1440P) 25FPS + 1080P 25FPS

1080P 25FPS + 1080P 25FPS

Loop Recording - 1 Min (Default)/ 2 Mins/ 3 Mins

Activate loop recording to ensure continuous video capture on your dash cam. When the memory card reaches capacity, the dash cam will automatically overwrite the oldest files, making room for new recordings. You can choose the length of each video file for loop recording.

Time-Lapse Recording - OFF (Default)/ 1 FPS/ 2 FPS/ 5 FPS

Enable time-lapse recording to capture video at a reduced frame rate, allowing for faster playback. This feature is ideal for condensing long drives into shorter videos.

Light Source Frequency - 50Hz (Default)/ 60Hz

50Hz and 60Hz power frequencies are suitable for different regions: 50Hz is suitable for Europe, Asia, Africa; 60Hz is suitable for North America, South America and some Asian countries. Choosing the appropriate frequency ensures the stability and effectiveness of your device when recording video.

G-Sensor - OFF/ Low/ Medium (Default)/ High

The G-Sensor detects accelerations and impacts. Higher sensitivity means less force is needed to trigger file protection. You can customize the dash cam's response to different driving situations.

Parking Mode G-Sensor - OFF/ Low/ Medium (Default)/ High

You can adjust the sensitivity to customize how the dash cam responds to disturbances while parked. If your vehicle is impacted, the parking mode G-Sensor will activate the dash cam, starting a 1-minute recording that will be saved in the "Video-Lock" folder.

Time-Lapse Parking Mode - OFF (Default)/ 1 FPS/ 2 FPS/ 5 FPS

1. When you turn off the car's engine, the camera will stop the normal video recording and switch to time-lapse mode

automatically.

2. If someone hits your car and the impact triggers the G-Sensor, the camera will save a 1-minute normal video clip and lock it in the "Video-Lock" before returning to time-lapse recording.

3. When you restart your car, the camera will automatically stop time-lapse mode and switch back to normal video recording.

Note: Parking mode settings will function only when the LINGDU Type-C Hardwire Kit is installed correctly, and the output current must reach 2.5A.

Time-Lapse Parking Duration - 12H/ 24H/ 48H/ 72H

Select the desired duration for time-lapse recording based on your needs.

Audio - OFF/ ON (Default)

Enable or disable the microphone during video recording.

Video Watermark

Enable or disable the display of the time stamp, GPS, speed, and LNDU logo stamps on the recorded files.

Rear Cam Display Options - OFF (Default)/ Flip/ Mirror/ Flip & Mirror

Customize the presentation of the rear camera footage on the dash cam screen, enhancing your visibility and assisting with parking and reversing maneuvers.

6/ SETTING THE SYSTEM

Volume Settings

Adjust the volume of the internal speaker to suit your preferences.

Key Tone - OFF/ ON (Default)

Customize your user experience by toggling the key tone sound on or off.

Screen Saver - OFF/ 1 Min/ 3 Mins

Set a screensaver duration of either 1 or 3 minutes. After the specified time of inactivity, the dash cam will automatically turn off the screen while continuing to record normally. To reactivate the display, simply touch the screen.

Speed Unit - KM/H (Default)/ MPH

Choose your preferred speed unit, either KMH or MPH.

Time Zone Selection

Customize the time display of your dash cam by adjusting it to your specific time zone. Changes will take effect once the device acquires a GPS connection, ensuring accurate time and date settings.

Language Settings - Multilingual

Select your preferred language for the user interface. The default setting will follow the selection made during your initial setup.

Satellite Information

Access real-time data regarding satellite connectivity, including satellite numbers, GPS status, as well as your current longitude and latitude coordinates.

Wi-Fi Info

Turn on or off the WiFi of the dash cam.

WiFi Name SSID: LNDU LD4K -*****

Default PWD: 12345678

WiFi Band - 2.4GHz/ 5.8GHz (Default)

Some mobile phones do not support 5.8G WiFi. If you can not find the WiFi of the dash cam in the WiFi list, please try to switch to 2.4G WiFi.

Voice Control - OFF/ ON (Default)

10 Voice Commands: Turn on WiFi; Turn off WiFi; Take picture; Lock the video; Open recording; Turn off recording; Open screen; Turn off display; Show front camera; Show rear camera.

Date & Time Settings

Adjust the time & date as required. Note: Time and date settings will be overwritten upon satellite connection.

Date & Time Display - OFF (Default)/ ON

Enable or disable the date & time display during video recording.

microSD Card Formatting

The formatting process will make sure that the card's file system format is optimized for the camera.

Note: For stable performance, it is recommended that you format the memory card every 1-2 months.

Version Information

Access the version information to check the current firmware of your dash cam, such as LNDU LD4K-20241228*****

Default Settings

Reset the dash cam to default settings. Your recordings will not be affected.

7/ COMPLIANCE AND SECURITY

General Troubleshooting

Camera turns ON/OFF automatically ?

Ensure that the output current can reach 5V/ 2.5A and use our car charger. And ensure that the rear camera are connected correctly. It is to improve stability that the dashcam reboots automatically once if it detects that there are different cameras connected.

The power is on, can not be turned on

If the Mirror dash cam does not function normally, try restarting it. To restart the Mirror dash cam with a flattened paper clip, press the small "Reset" hole on top of the device next to the USB port.

Video does not play smoothly

You are viewing high-bit rate version of video files. General computer configuration may have problem with faster data processing. Please record videos at lower resolution and try again. If this does not solve the problem, please contact us

service@lingdu.us

Device fails to record video or take a picture

Plug in the card. If the card is not recognized, unplug it and plug it in again, or clean up any contamination from the card contacts. If not solved, format the memory card in dash cam.

All buttons fail to function

Press Reset Key to restart the device;

If not solved, remove the memory card or rear camera to confirm if the accessories have a effect on it.

Why the rear cam image is converse on the screen?

According to your habit, please set the function named "Rear Video Mirror" at OFF.

Why dash cam can't get the GPS signal?

1. Check if the GPS icon status on the screen. (it will take 1-3 minutes to get GPS signal successfully)
2. Depending on the vehicle and the location of the GPS signal can be blocked due to strong radio interference of other electronic devices in the car, the cloudy/rainy w tall buildings on both sides of road etc.
3. Please check if GPS works by taking the GPS Module from the car to outside. If it works then there must be a heavy interference in the car, for example thick car Explosion-proof membrane, metal item and etc.

Time display is incorrect after setting

Please ensure to choose the correct time zone when GPS antenna is connected.

The Time Zone settings that influence the displayed time & date will be applied upon receiving a GPS connection. Some examples of GMT time off sets are:

-GMT-7: LosAngeles -GMT-4: NewYork -GMT+10: Sydney

Please make sure to adjust time zone setting during standard vs. daylight savings time.

If you are unsure of your GMT off set please look up your city on www.greenwichmeantime.com/time-zone/usa/

Dash cam will be warm

It is normal. A dash cam of this caliber is a pretty high-tech piece of equipment. When you think about it from an engineering perspective, capturing high quality full HD video takes a large amount of computer processing power. Heat is the by-product of

all that data processing that is going on. But not to worry. The case of the Dash cam itself is actually used as a heat-sink (notice the nice vents you see along the top and bottom of these models), so that's why you may notice it is warm or hot to the touch. Don't worry this is normal, and your LNDU is operating as designed.

Video has no sound?

Ensure that "Record Audio" icon is turned ON. Ensure that "TimeLapse Parking Mode" setting is turned OFF within the Menu.

Important Safety Information

- Please read this manual carefully before operation and keep it for future reference. It will be helpful should you encounter any operational problem.
- Please only use LNDU car charger in this package .
- Be sure to format your microSD card with your dashcam for the first time use. Periodically reformat the memory card. Every 2-3 weeks we recommend that you reformat the memory card. As formatting the card will remove all content, firstly you could download any files from the card that you may want to keep.
- Do not remove or insert the memory card when the Stream Media Mirror Dash Camera is turned on. This may damage the memory card.
- Do not remove or insert GPS or rear camera when the Stream Media Mirror Dash Camera is turned on. This may damage the camera.
- The camera is designed to power up and record automatically when it receives power. Then saves the video record and turns off automatically when the car shuts off.
- Please MAKE SURE to connect all cameras and wires BEFORE power ON the Mirror Screen, otherwise, the camera cannot work properly.

- Improper installation will void manufacturer's warranty. The installation instructions do not apply to all types of vehicles, and are written as guidelines to assist in installing the system.
- Consult an experienced technician if you are not comfortable installing the product.
- Do not expose this product to rain, moisture or water under any circumstances, doing so may result in the risk of electric shock or fire.
- Do not obscure the view of the road ahead or impede the deployment of any airbags in the event of an accident.
- Only clean the device with a soft dry cloth, for tough dirt, apply some neutral detergent diluted in 5 to 6 parts water to a soft cloth.
- Note that alcohol, thinner, benzene etc could cause damage to the paint or coatings.
- Avoid making contact with the Lens as damage may be caused.
- If required clean the glass lens carefully using spectacle lens cleaning fluid on a soft cloth only.
- The video recordings made by this Digital Video Recorder are intended for personal use only.
- Whilst driving, do not adjust the controls of your device as this is a distraction to driving.

Notice

 This product complies with the radio interface requirements of the European Community.

 This symbol means the product must not be discarded as household waste, and should be delivered to an appropriate and recycling helps protect natural resources, human health and the environment. For more information on disposal and recycling of this product, contact your local municipality, disposal service, or the shop where you bought this product.

 Changes or modifications not expressly approved by the party responsible for compliance could void the user's authority to operate the equipment.

This equipment has been tested and found to comply with the limits for a Class B digital device, pursuant to Part 15 of the FCC Rules. These limits are designed to provide reasonable protection against harmful interference in a residential installation. This equipment generates, uses and can radiate radio frequency energy and, if not installed and used in accordance with the instructions, may cause harmful interference to radio communications. However, there is no guarantee that interference will not occur in a particular installation.

If this equipment does cause harmful interference to radio or television reception, which can be determined by turning the equipment off and on, the user is encouraged to try to correct the interference by one or more of the following measures:

- Reorient or relocate the receiving antenna.
- Increase the separation between the equipment and receiver.
- Connect the equipment into an outlet on a circuit different from that to which the receiver is connected.
- Consult the dealer or an experienced radio/ TV technician for help.